

ESD TVS Array in SOT-23

Features

- 400Watts peak pulse power ($T_P = 8/20\mu s$)
- Tiny SOT-23 package
- Bidirectional configurations
- Protects two I/O port
- Low clamping voltage
- Low leakage current
- Protection one data/power line to:
IEC 61000-4-2 $\pm 30kV$ contact $\pm 30kV$ air
IEC 61000-4-4 (EFT) 40A (5/50ns)
IEC 61000-4-5 (Lightning) 17A (8/20 μs)

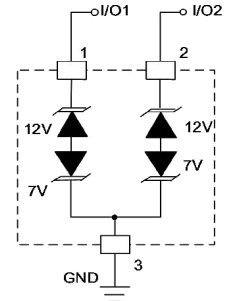
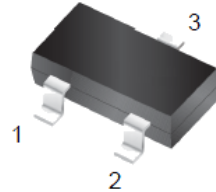

Mechanical Data

- **Case:** SOT-23 (plastic package).
Lead free; RoHS compliant; Halogen free
- **Molding Compound Flammability Rating:**
UL 94 V-0
- **Terminals:** High temperature soldering guaranteed:
260 °C/10 sec. at terminals

Applications

- Dataline
- Automatic Teller Machines
- Net works
- Power line

Absolute Maximum Ratings

Ratings at 25 °C, ambient temperature unless otherwise specified

Parameter	Symbol	Value	Unit
Peak Pulse Power ($T_P=8/20\mu s$)	P_{PP}	400	W
ESD contact/air discharge (IEC-61000-4-2)	V_{ESD}	30/30	kV
Peak Pulse Current ($T_P = 8/20\mu s$)	I_{PP}	12	A
Junction Temperature	T_J	-55 to +125	°C
Storage temperature	T_{STG}	-55 to +150	°C

Electrical Characteristics

($T_A = 25\text{ °C}$ unless otherwise specified)

Parameter	Symbol	Conditions	Pins 1 to 3 and 2 to 3 (12V TVS)			Pins 3 to 1 and 3 to 2 (7V TVS)			Unit
			Min	Typ	Max	Min	Typ	Max	
Reverse Stand-Off Voltage	V_{RWM}				12			7	V
Reverse Breakdown Voltage	V_{BR}	$I_T=1mA$	13.3	14		7.5	9.5		V
Reverse Leakage Current	I_R	$V_R=V_{RWM}$			1			1	μA
Clamping Voltage	V_C	$I_{PP}=17A, T_P=8/20\mu s$		24			10		V
Junction Capacitance	C_j	$V_R = 0V, f = 1MHz$		45			45		pF

Typical Characteristics ($T_{amb} = 25\text{ }^{\circ}\text{C}$ unless otherwise specified)

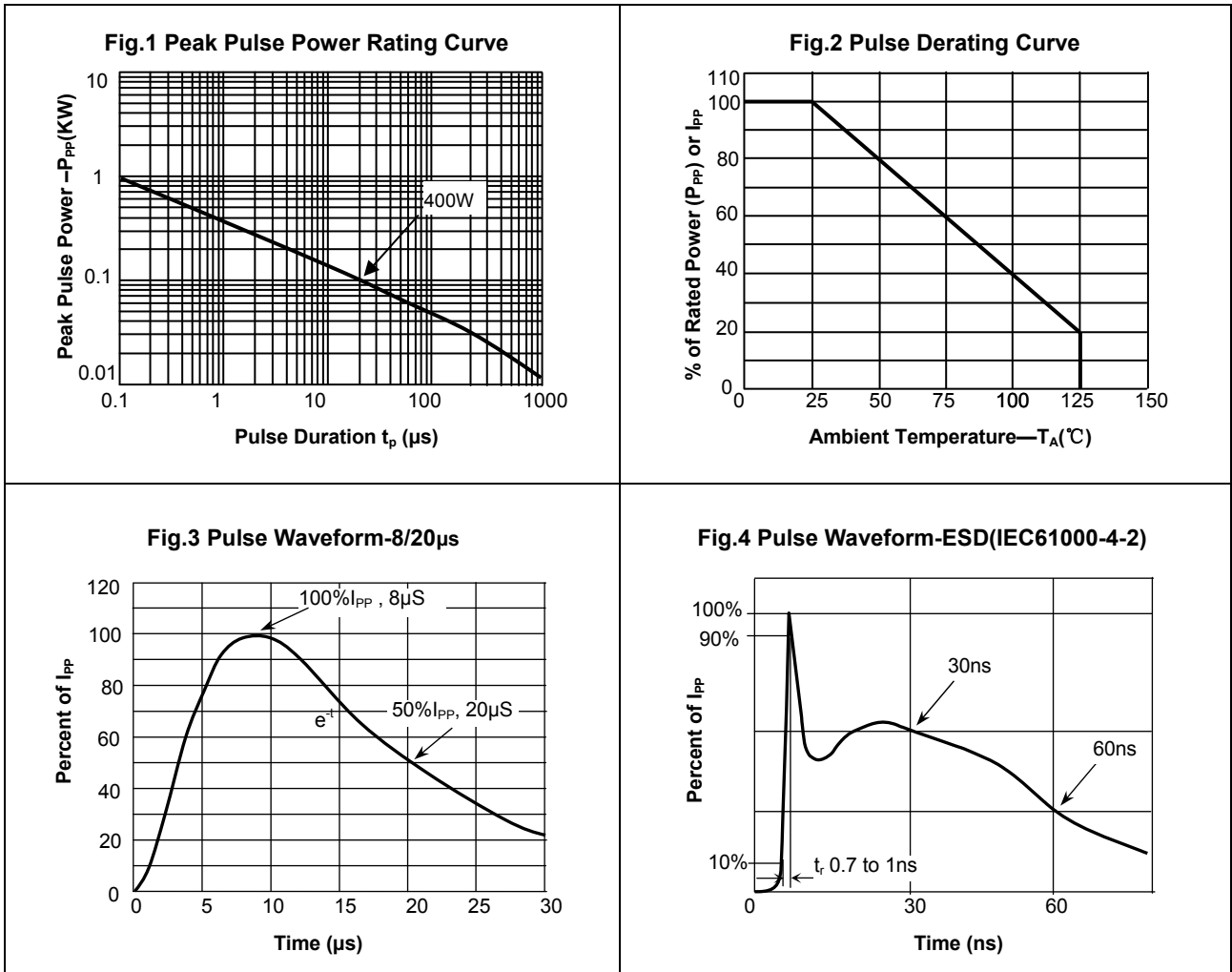

Package Dimensions

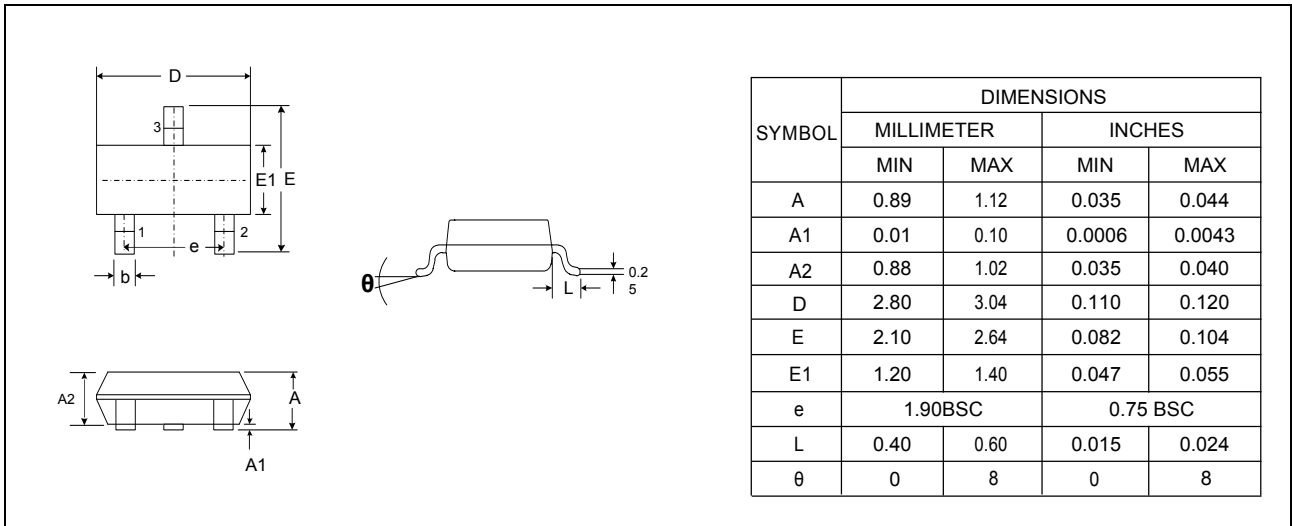

Pad Dimensions

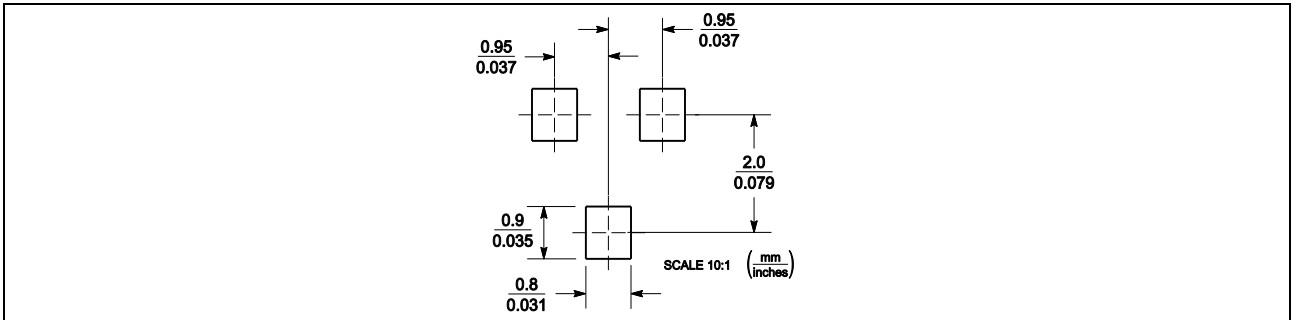

Package Information

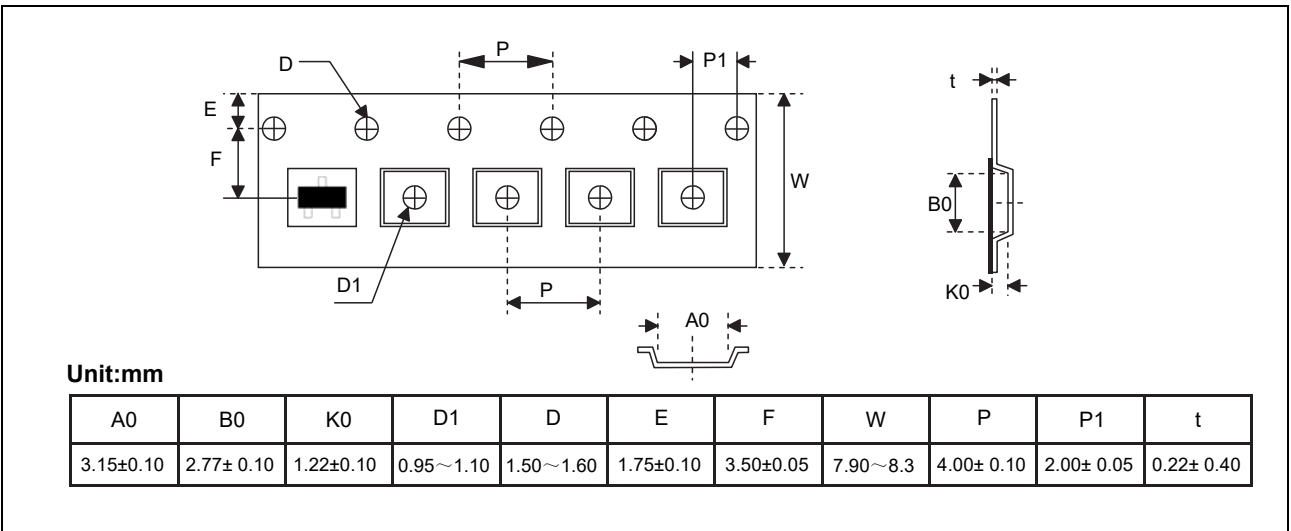

Marking

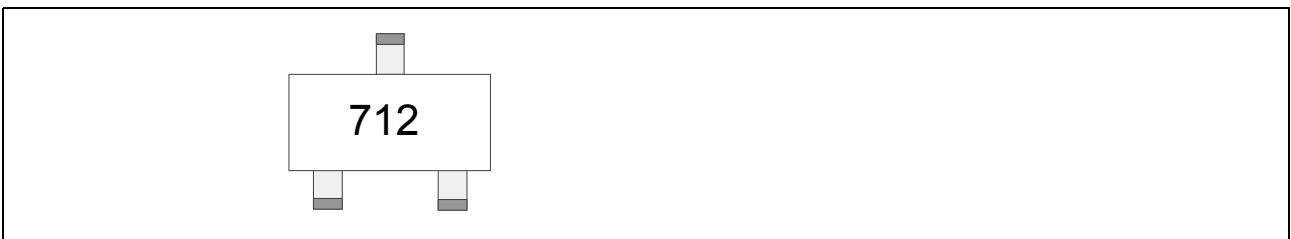

Ordering information

Order code	Package	Packaging option	Base quantity	Packaging specification
CES712M	SOT-23	Tape and reel	3000pcs / reel	EIA STD RS-481

Revision history

Date	Revision	Changes
23-May-2020	1.0	Initial release

CAUTION / WARNING

Information in this document is believed to be accurate and reliable. However, RDSEMI does not give any representations or warranties, expressed or implied, as to the accuracy or completeness of such information and shall have no liability for the consequences of use of such information.

Users should independently evaluate the suitability of and test each product selected for their own applications, and RDSEMI assumes no liability what's ever relating to the choice, selection or use of the RDSEMI products and services described herein.

RDSEMI reserves the right to change or update, without notice, any information contained in this publication; to change, without notice, the design, construction, processing, or specification of any product; and to discontinue or limit production or distribution of any product.

Information in this document supersedes and replaces all information previously supplied.

Products are not designed, authorized or warranted to be suitable for use in medical, military, aircraft, space or life support equipment, nor in applications where failure or malfunction of an RDSEMI product can reasonably be expected to result in personal injury, death or severe property or environmental damage. RDSEMI accepts no liability for inclusion and/or use of RDSEMI products in such equipment or applications and therefore such inclusion and/or use is at the customer's own risk.

This document as well as the item(s) described herein may be subject to export control regulations. Export might require a prior authorization from national authorities.

Resale of RDSEMI products with provisions different from the statements and/or technical features set forth in this document shall immediately void any warranty granted by RDSEMI for the RDSEMI product or service described herein and shall not create or extend in any manner whatsoever, any liability of RDSEMI.

RDSEMI expressly disclaims all implied warranties regarding the information contained herein, including, but not limited to, any implied warranties of merchantability or fitness for a particular purpose. RDSEMI only obligations are those in the RDSEMI Standard Terms and Conditions of Sale and in no case will RDSEMI be liable for any incidental, indirect, or consequential damages arising from the sale, resale, use, or misuse of its products.

Specifications are subject to change without notice
© Copyright 2020, DaJing Semiconductor
All rights reserved