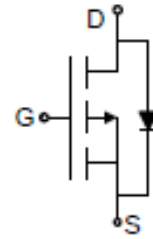

-20V P-Channel MOSFETs
Description
Features

- $V_{DS} = -20V$, $I_D = -3.4A$
- $R_{DS(ON)} < 65m\Omega$ @ $V_{GS} = -4.5V$
 $R_{DS(ON)} < 90m\Omega$ @ $V_{GS} = -2.5V$
- High Power and Current Handling Capability
- Lead Free Product is Acquired
- Surface Mount Package

RoHS
 COMPLIANT

SOT-23

Application

- PWM Applications
- Load Switch
- Power Management

Absolute Maximum Ratings ($T_C = 25^\circ C$ unless otherwise specified)

Symbol	Parameter	Max.	Units
V_{DSS}	Drain-Source Voltage	-20	V
V_{GSS}	Gate-Source Voltage	± 12	V
I_D	Continuous Drain Current	$T_C = 25^\circ C$	-3.4
		$T_C = 100^\circ C$	-2.2
I_{DM}	Pulsed Drain Current ^{note1}	-12	A
P_D	Power Dissipation	$T_A = 25^\circ C$	1
$R_{\theta JA}$	Thermal Resistance, Junction to Ambient	125	$^\circ C/W$
T_J, T_{STG}	Operating and Storage Temperature Range	-55 to +150	$^\circ C$

Electrical Characteristics ($T_C=25^\circ\text{C}$ unless otherwise specified)

Symbol	Parameter	Test Condition	Min.	Typ.	Max.	Units
Off Characteristic						
$V_{(BR)DSS}$	Drain-Source Breakdown Voltage	$V_{GS}=0V, I_D = -250\mu A$	-20	-	-	V
I_{DSS}	Zero Gate Voltage Drain Current	$V_{DS} = -20V, V_{GS} = 0V,$	-	-	-1	μA
I_{GSS}	Gate to Body Leakage Current	$V_{DS} = 0V, V_{GS} = \pm 12V$	-	-	± 100	nA
On Characteristics						
$V_{GS(th)}$	Gate Threshold Voltage	$V_{DS} = V_{GS}, I_D = -250\mu A$	-0.5	-0.7	-1.0	V
$R_{DS(on)}$	Static Drain-Source on-Resistance <small>note2</small>	$V_{GS} = -4.5V, I_D = -3.4A$	-	50	65	m Ω
		$V_{GS} = -2.5V, I_D = -2A$	-	61	90	
g_{FS}	Forward Transconductance	$V_{DS} = -5V, I_D = -3.4A$	5	-	-	S
Dynamic Characteristics						
C_{iss}	Input Capacitance	$V_{DS} = -10V, V_{GS} = 0V,$ $f = 1.0MHz$	-	485	-	pF
C_{oss}	Output Capacitance		-	83	-	pF
C_{rss}	Reverse Transfer Capacitance		-	55	-	pF
Q_g	Total Gate Charge	$V_{DS} = -10V, I_D = -3.4A,$ $V_{GS} = -4.5V$	-	4.0	-	nC
Q_{gs}	Gate-Source Charge		-	0.8	-	nC
Q_{gd}	Gate-Drain("Miller") Charge		-	1.3	-	nC
Switching Characteristics						
$t_{d(on)}$	Turn-on Delay Time	$V_{DD} = -10V, I_D = -1A,$ $R_{GEN}=10\Omega, V_{GE}=-4.5V,$	-	11	-	ns
t_r	Turn-on Rise Time		-	35	-	ns
$t_{d(off)}$	Turn-off Delay Time		-	30	-	ns
t_f	Turn-off Fall Time		-	10	-	ns
Drain-Source Diode Characteristics and Maximum Ratings						
I_S	Maximum Continuous Drain to Source Diode Forward Current		-	-	-3.4	A
I_{SM}	Maximum Pulsed Drain to Source Diode Forward Current		-	-	-12	A
V_{SD}	Drain to Source Diode Forward Voltage	$V_{GS} = 0V, I_S = -1.7A$	-	-	-1.2	V

Notes:1. Repetitive Rating: Pulse Width Limited by Maximum Junction Temperature

2. Pulse Test: Pulse Width $\leq 300\mu s$, Duty Cycle $\leq 2\%$

Typical Performance Characteristics

Figure 1: Output Characteristics

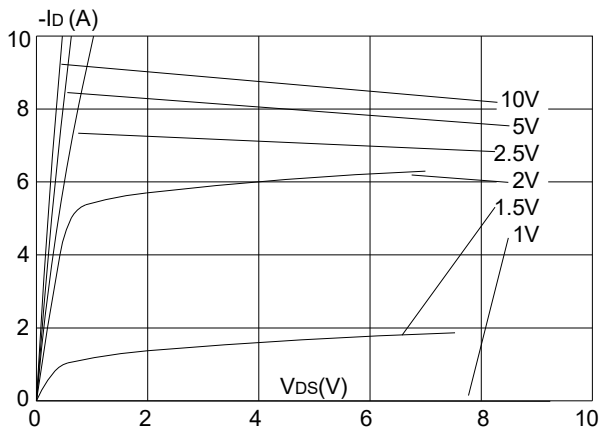

Figure 2: Typical Transfer Characteristics

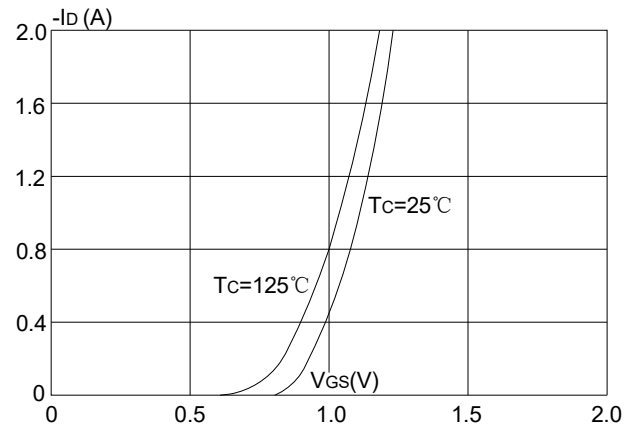

Figure 3: On-resistance vs. Drain Current

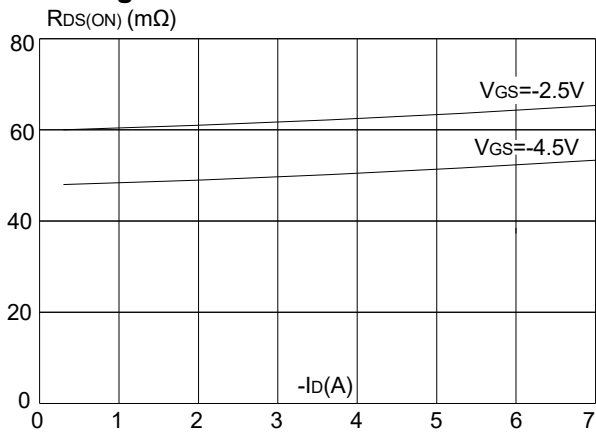

Figure 4: Body Diode Characteristics

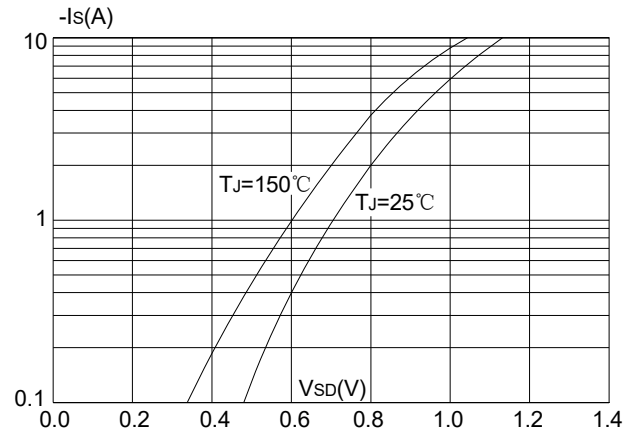

Figure 5: Gate Charge Characteristics

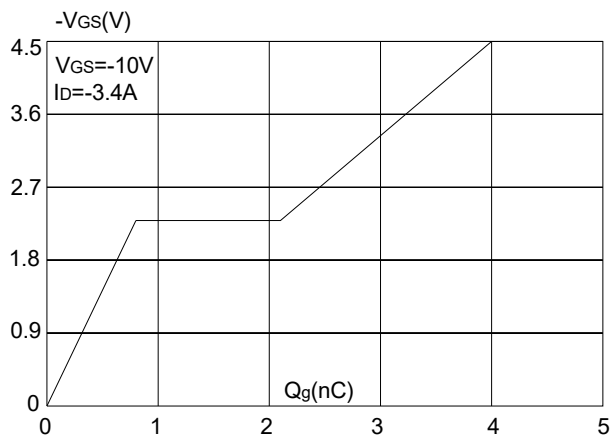

Figure 6: Capacitance Characteristics

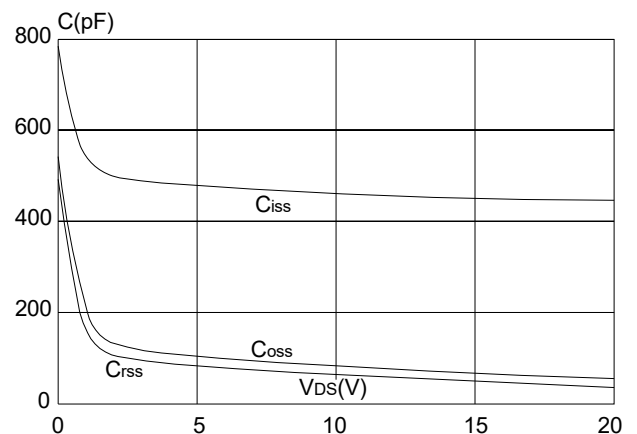

Figure 7: Normalized Breakdown Voltage vs. Junction Temperature

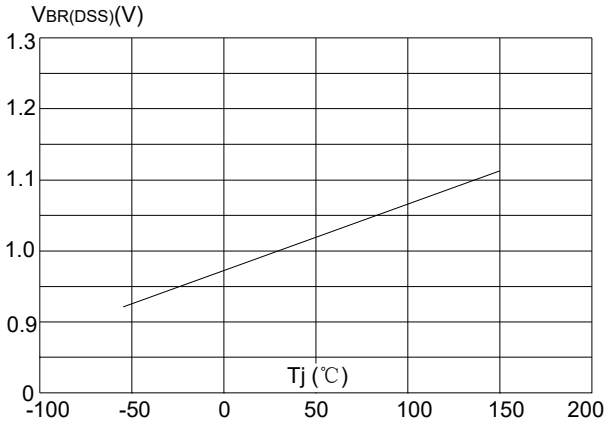

Figure 8: Normalized on Resistance vs. Junction Temperature

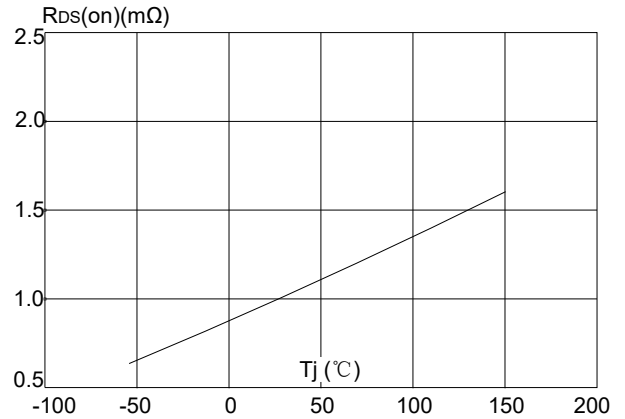

Figure 9: Maximum Safe Operating Area

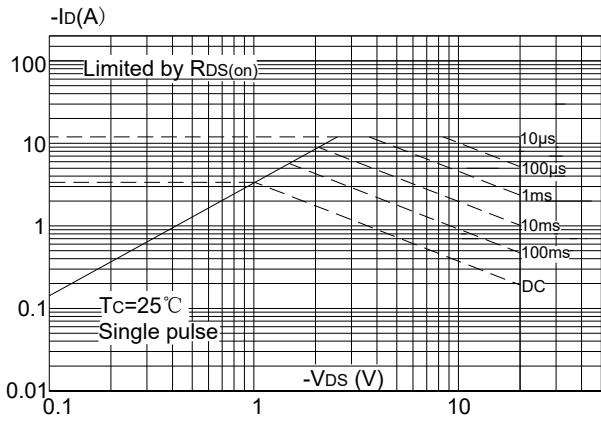

Figure 10: Maximum Continuous Drain Current vs. Case Temperature

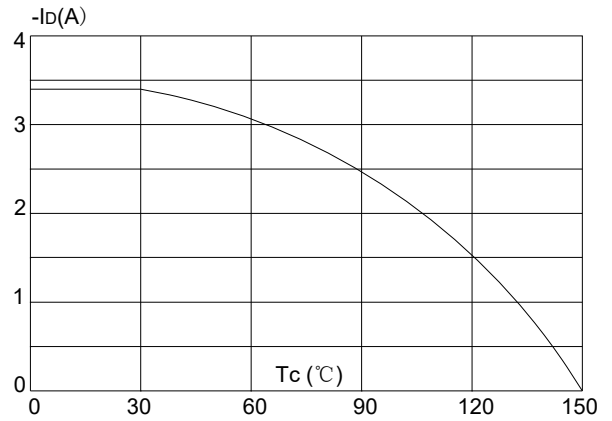
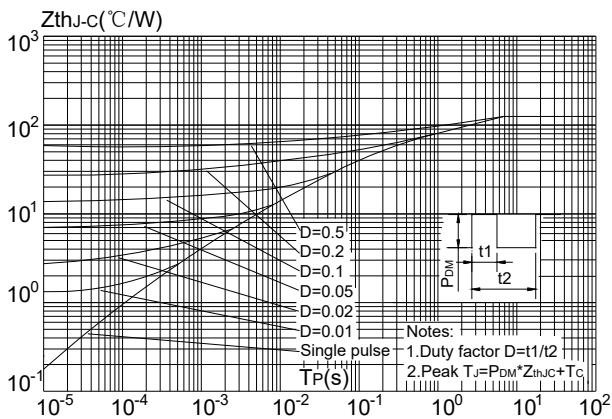

Figure.11: Maximum Effective Transient Thermal Impedance, Junction-to-Ambient (SOT-23)



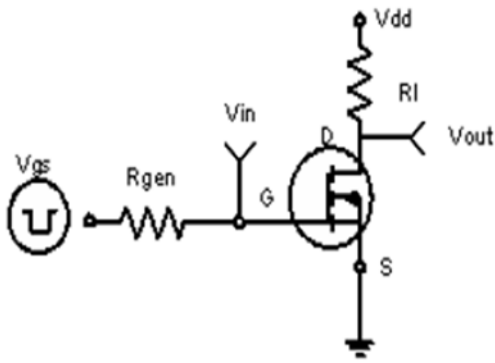

Figure1:Switching Test Circuit

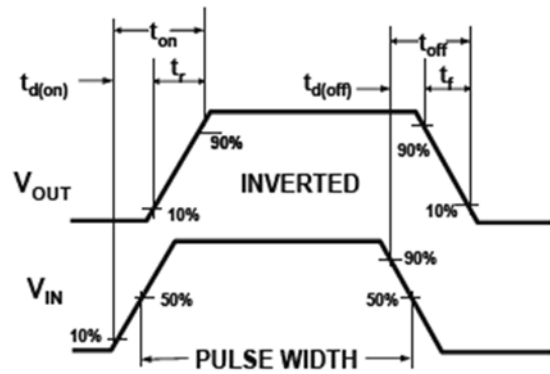
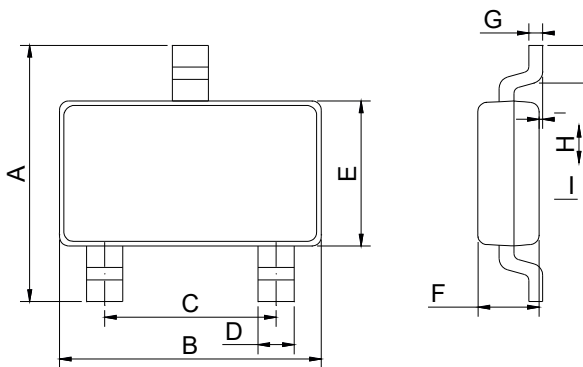

Figure2:Switching Waveforms

Package Mechanical Data



SOT-23

Ref.	Dimensions					
	Millimeters			Inches		
	Min.	Typ.	Max.	Min.	Typ.	Max.
A	2.30	2.40	2.50	0.091	0.095	0.098
B	2.80	2.90	3.00	0.110	0.114	0.118
C	1.90 REF			0.075 REF		
D	0.35	0.40	0.45	0.014	0.016	0.018
E	1.20	1.30	1.40	0.047	0.051	0.055
F	0.90	1.00	1.10	0.035	0.039	0.043
G		0.10	0.15		0.004	0.006
H	0.20			0.008		
I	0		0.10	0		0.004

Package Information-SOT-23

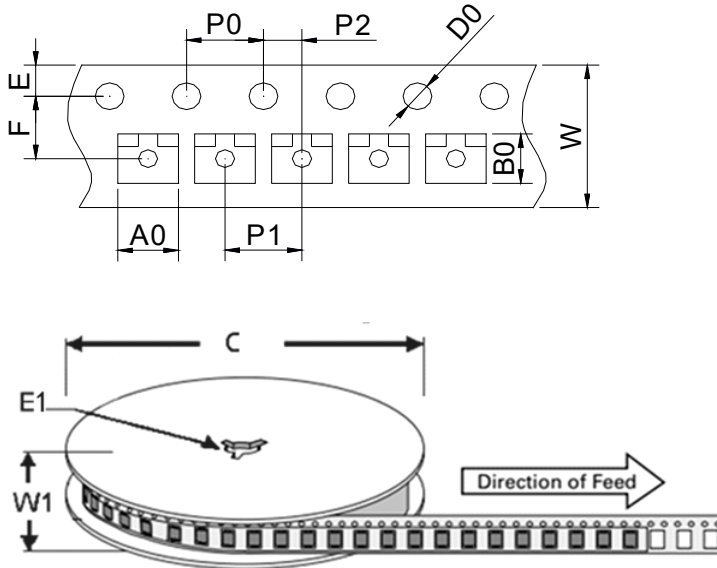

Ref.	Dimensions	
	Millimeters	Inches
A0	3.15 ± 0.3	0.124 ± 0.012
B0	2.77 ± 0.3	0.109 ± 0.012
C	178	7.0
D0	1.50±0.1	0.059 ± 0.004
E	1.75 ± 0.2	0.069 ± 0.008
E1	13.3±0.3	0.524± 0.012
F	3.5 ± 0.2	0.138 ± 0.008
P0	4.00 ± 0.2	0.157 ± 0.008
P1	4.00 ± 0.2	0.157 ± 0.008
P2	2.00 ± 0.2	0.079 ± 0.008
W	8.00 ± 0.2	0.315 ± 0.008
W1	11.5±1.0	0.453 ± 0.039

Ordering Information-SOT-23

OUTLINE	PACKAGE TYPE	QUANTITY REEL	DESCRIPTION
TAPING	SOT-23	3,000pcs	7 inch reel pack

Revision history

Date	Revision	Changes
28-May-2020	1.0	Initial release

CAUTION / WARNING

Information in this document is believed to be accurate and reliable. However, RDSEMI does not give any representations or warranties, expressed or implied, as to the accuracy or completeness of such information and shall have no liability for the consequences of use of such information.

Users should independently evaluate the suitability of and test each product selected for their own applications, and RDSEMI assumes no liability what's ever relating to the choice, selection or use of the RDSEMI products and services described herein.

RDSEMI reserves the right to change or update, without notice, any information contained in this publication; to change, without notice, the design, construction, processing, or specification of any product; and to discontinue or limit production or distribution of any product.

Information in this document supersedes and replaces all information previously supplied.

Products are not designed, authorized or warranted to be suitable for use in medical, military, aircraft, space or life support equipment, nor in applications where failure or malfunction of an RDSEMI product can reasonably be expected to result in personal injury, death or severe property or environmental damage. RDSEMI accepts no liability for inclusion and/or use of RDSEMI products in such equipment or applications and therefore such inclusion and/or use is at the customer's own risk.

This document as well as the item(s) described herein may be subject to export control regulations. Export might require a prior authorization from national authorities.

Resale of RDSEMI products with provisions different from the statements and/or technical features set forth in this document shall immediately void any warranty granted by RDSEMI for the RDSEMI product or service described herein and shall not create or extend in any manner whatsoever, any liability of RDSEMI.

RDSEMI expressly disclaims all implied warranties regarding the information contained herein, including, but not limited to, any implied warranties of merchantability or fitness for a particular purpose. RDSEMI only obligations are those in the RDSEMI Standard Terms and Conditions of Sale and in no case will RDSEMI be liable for any incidental, indirect, or consequential damages arising from the sale, resale, use, or misuse of its products.

Specifications are subject to change without notice
© Copyright 2020, DaJing Semiconductor
All rights reserved